

Dark Matter: Theory Overview

Howard Baer

Florida State University

- ★ Evidence for CDM
- ★ Candidates for CDM
 - Axions
 - Supersymmetry LSP
 - Others (LKP, PBH, branons, ...)
- ★ Neutralinos in mSUGRA
 - Relic density
 - Direct and indirect detection of DM
 - DM detection at colliders
- ★ Beyond mSUGRA

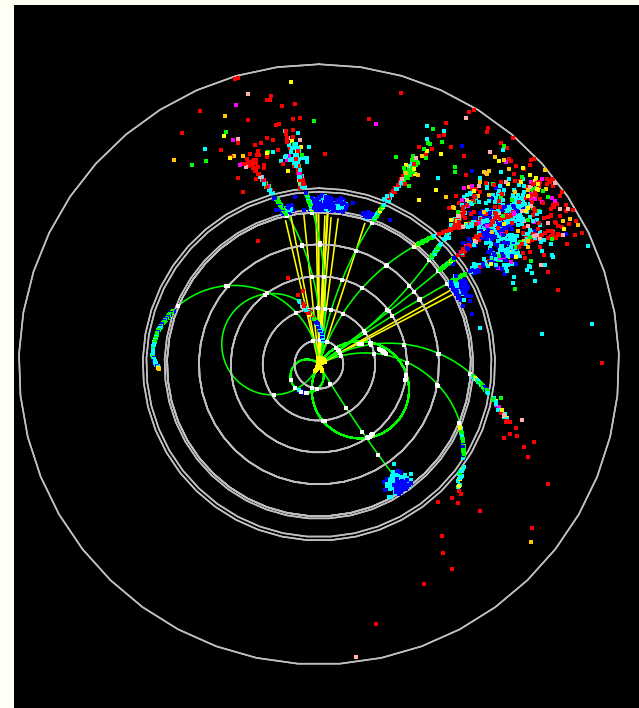

Evidence for Dark Matter/Dark Energy

- ★ Binding of clusters
- ★ Galactic rotation curves
- ★ Gravitational lensing
- ★ CMB fluctuations
- ★ Large scale structure
- ★ Standard cosmological model: Λ CDM
 - $\Omega_B h^2 = 0.023 \pm 0.001$
 - $\Omega_\nu h^2 < 0.0076$ 95% CL
 - $\Omega_\Lambda h^2 \sim 0.35$
 - $\Omega_{CDM} h^2 = 0.113 \pm 0.009$

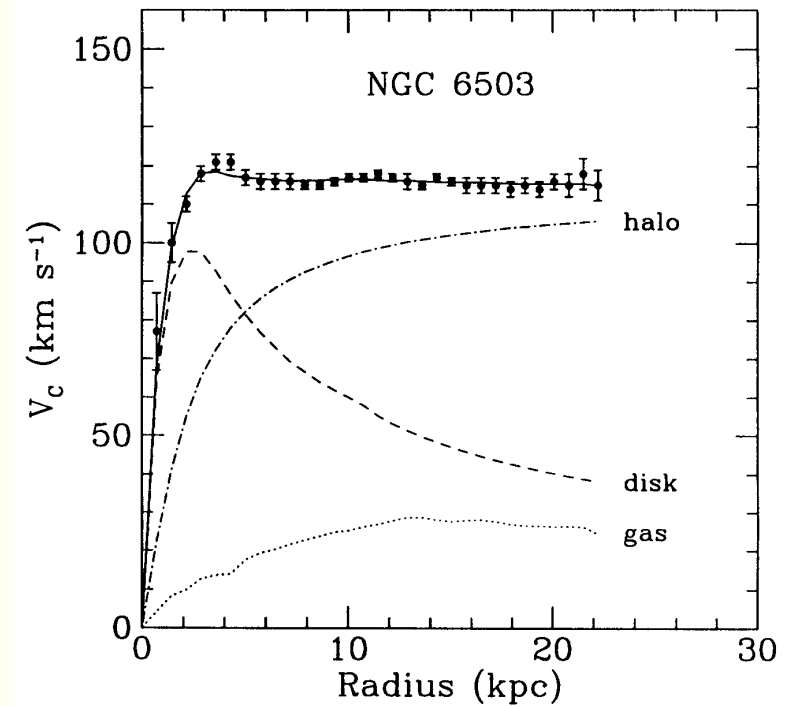

Dark matter vs. dark energy

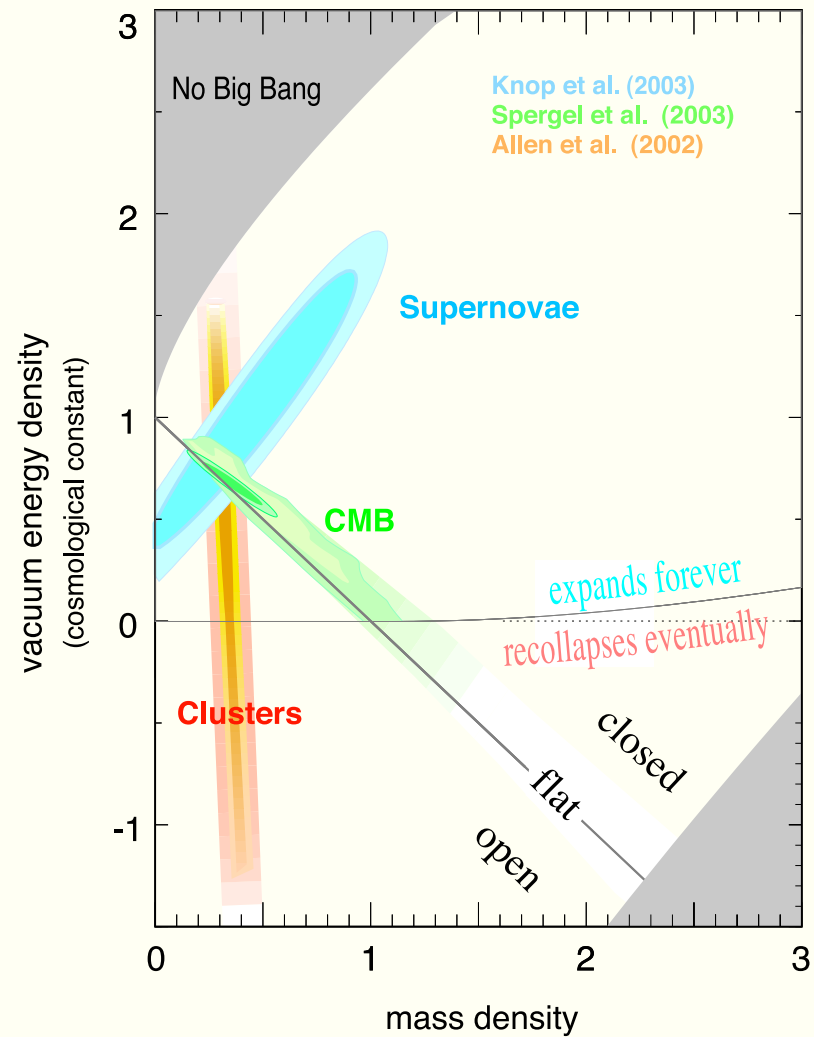

Candidates for Dark Matter

- ★ unseen baryons, e.g. BHs, brown dwarves, stellar remnants
 - inconsistent with BBN element abundance calc'n
 - limits from MACHO, EROS, OGLE
- ★ neutrinos (= *HDM*); str. form'n needs CDM
- ★ axions
- ★ WIMPS
 - RPC supersymmetry: LSP
 - UED: lightest KK particle (Servant, Tait)
 - Little Higgs models: lightest *T*-odd ptcl
 - Branons (XDDM)
 - Wimpzillas?

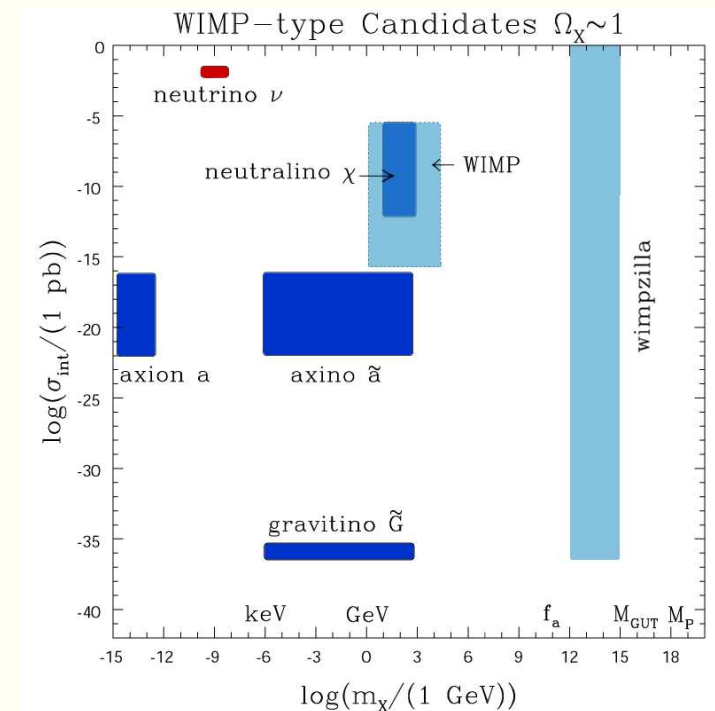

L. Roszkowski plot

Axions

- ★ Peccei-Quinn solution to strong CP problem in QCD
- ★ pseudo-Goldstone boson from PQ symmetry breaking at scale f_a
- ★ non-thermally produced via vacuum mis-alignment
 - $m_a \sim \Lambda_{QCD}^2 / f_a \sim 10^{-6} - 10^2 \text{ eV}$
 - $\kappa_a, \theta_i \sim 1$
 - $\Omega_a h^2 = \kappa_a (f_a / 10^{12} \text{ GeV})^{1.175} \theta_i^2 \sim 10^{-8} - 10^2$
 - (must be lucky to get $\Omega_a h^2 \sim 0.11$)
 - a couples to EM field: $a - \gamma - \gamma$ coupling (Sikivie)
 - axion microwave cavity searches
 - astrophysical bounds: stellar cooling via a emission

Constraints from axion searches

- ongoing microwave cavity searches: ADMX/ CARRACK

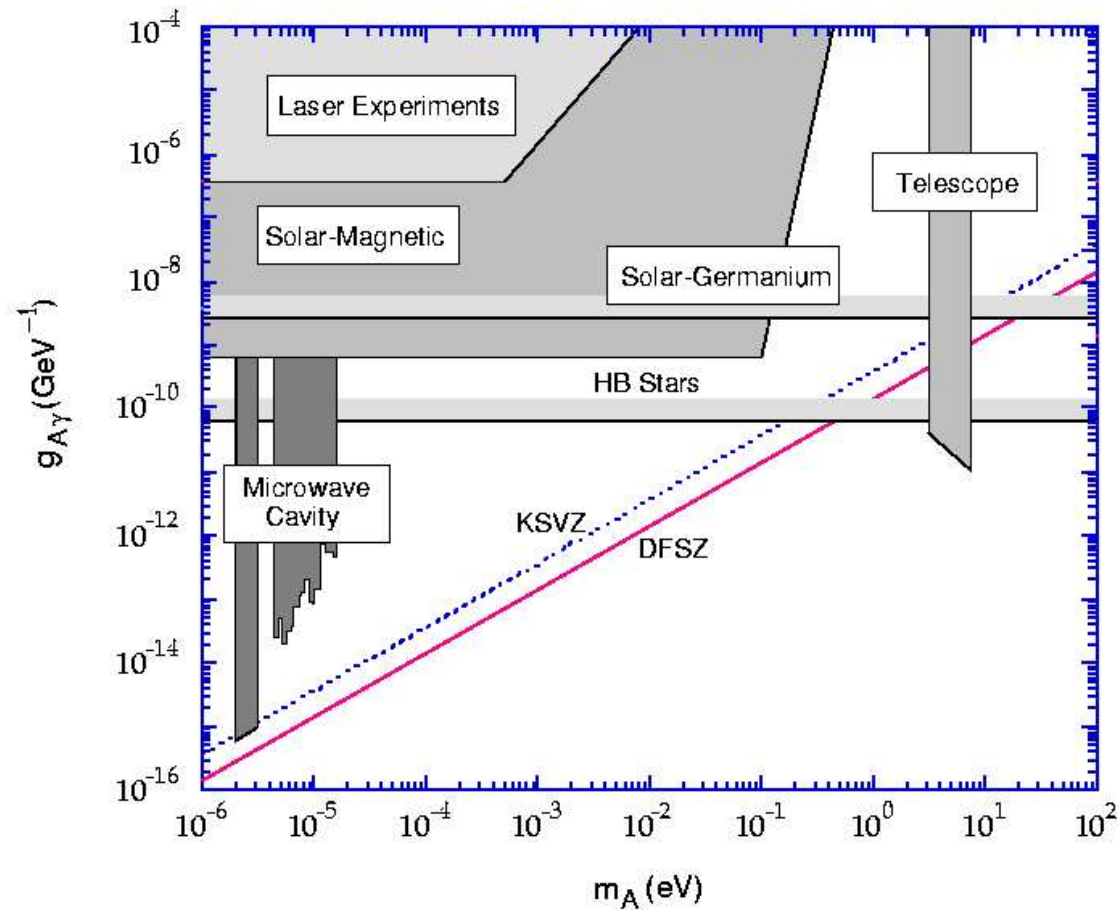

Supersymmetry: fermions \Leftrightarrow bosons

- ★ MSSM: doubling of spectra
 - spin-0 squarks, sleptons
 - spin- $\frac{1}{2}$ charginos, neutralinos, gluino
 - extra Higgses: h, H, A, H^\pm
 - R-parity cons'n: LSP is stable

★ LSP candidates

- sneutrinos (excluded)
- gravitinos (superWIMPs)
- neutralinos
- GMSB messengers
- hidden sector states
- axino/saxion

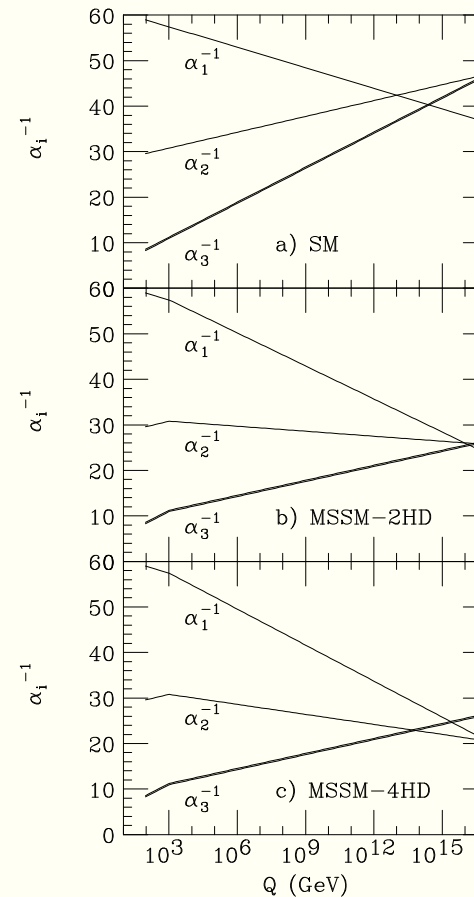

Gravity-mediated SUSY breaking models

- ★ $m_{3/2} \sim M_s^2/M_{Pl} \sim 10^3$ GeV for $M_s \sim 10^{11}$ GeV
- ★ theory below $Q = M_{GUT}$ usually assumed to be MSSM
- ★ Soft SUSY breaking boundary conditions usually stipulated at $Q = M_{GUT}$
- ★ lots of possibilities depending on SUSY breaking/ GUTs/ compactification ...
(all unknown physics)
- ★ minimal choice: single scalar mass m_0 , gaugino mass $m_{1/2}$, trilinear term A_0 , bilinear term B
- ★ evolve couplings/soft terms to M_{weak} via RG evolution
- ★ EWSB radiatively due to large m_t
- ★ parameter space: $m_0, m_{1/2}, A_0, \tan\beta, sign(\mu)$
- ★ this is simplest choice and a baseline model, but **many** other possibilities depending on high scale physics

- non-universal scalar masses
- non-universal gaugino masses
- FC soft SUSY breaking terms
- large CP violating phases
- additional fields beyond MSSM below M_{GUT} ?
- ...

Constraints on SUSY models

★ LEP2:

- $m_h > 114.4$ GeV for SM-like h
- $m_{\widetilde{W}_1} > 103.5$ GeV
- $m_{\widetilde{e}_{L,R}} > 99$ GeV for $m_{\widetilde{\ell}} - m_{\widetilde{Z}_1} > 10$ GeV

★ $BF(b \rightarrow s\gamma) = (3.25 \pm 0.54) \times 10^{-4}$

- SM theory: $BF(b \rightarrow s\gamma) \simeq 3.3 - 3.7 \times 10^{-4}$

★ $a_\mu = (g - 2)_\mu/2$

- $\Delta a_\mu = (27.1 \pm 9.4) \times 10^{-10}$ (Davier et al. e^+e^-)
- $\Delta a_\mu^{SUSY} \propto \frac{m_\mu^2 \mu M_i \tan \beta}{M_{SUSY}^4}$

★ $BF(B_s \rightarrow \mu^+ \mu^-) < 2.6 \times 10^{-6}$ (CDF)

- constrains at very large $\tan \beta \gtrsim 50$

★ WMAP: $\Omega_{CDM} h^2 = 0.113 \pm 0.009$

Neutralino dark matter

- ★ Why R -parity? natural in $SO(10)$ SUSYGUTS if properly broken, or broken via compactification (Mohapatra, Martin, Kawamura, ...)
- ★ In thermal equilibrium in early universe
- ★ As universe expands and cools, freeze out
- ★ Number density obtained from Boltzmann eq'n
 - $dn/dt = -3Hn - \langle \sigma v_{rel} \rangle (n^2 - n_0^2)$
 - depends critically on thermally averaged annihilation cross section times velocity
- ★ many thousands of annihilation/co-annihilation diagrams
- ★ equally many computer codes
 - Neutdriver (Jungman; not maintained)
 - DarkSUSY: (Gondolo, Edsjo, Ullio, Bergstrom, Schelke, Baltz)

- Micromegas (Belanger, Boudjema, Pukhov, Semenov)
- IsaRED: (HB, Balazs, Belyaev)
- SSARD: (Ellis, Falk and Olive)
- Drees/ Nojiri code
- Roszkowski code
- Arnowitt/ Nath code
- Lahanas/ Nanopoulos code
- Bottino/ Fornengo *et al.* code
- ...

Dark matter number density vs. time

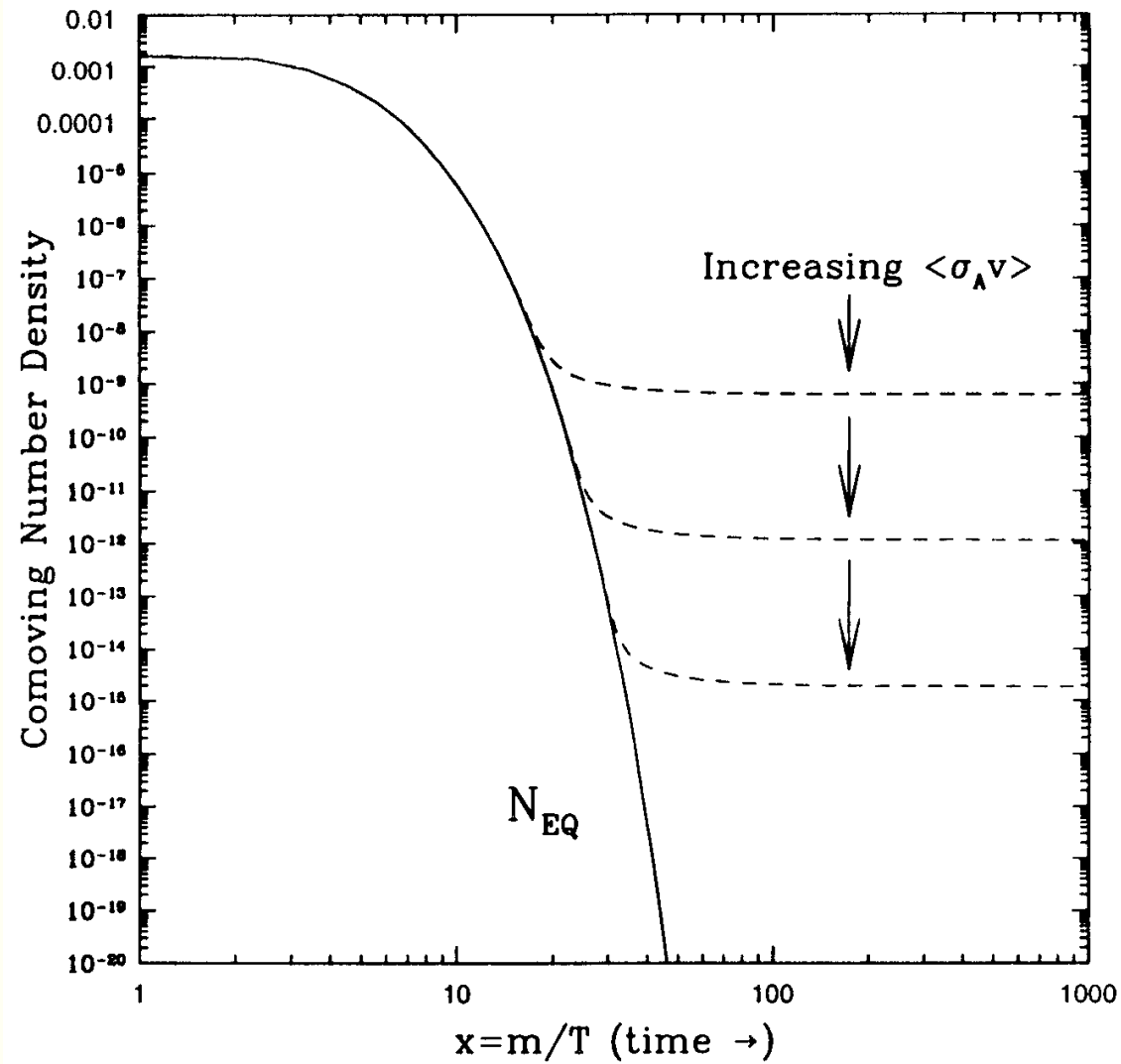

Some neutralino (co)annihilation processes

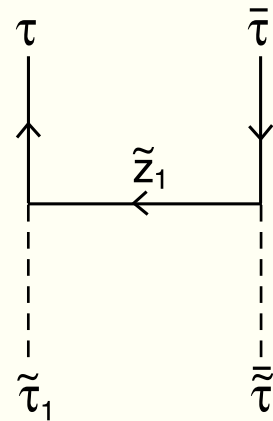
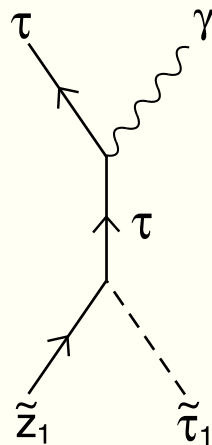
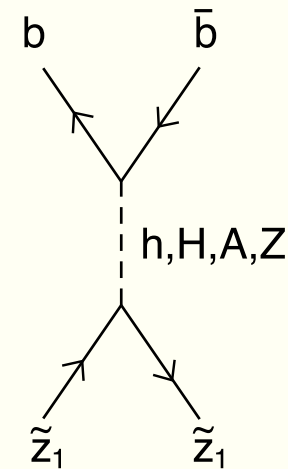
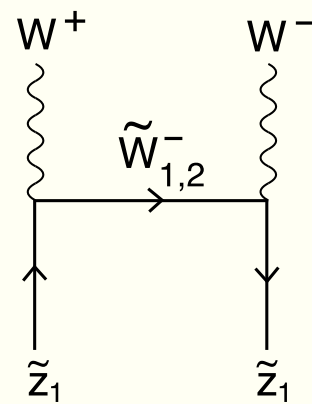
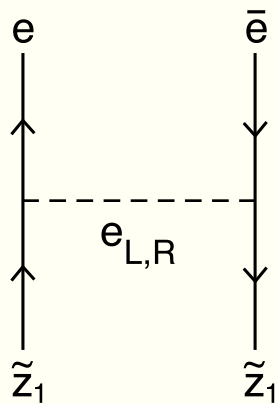

Effect of constraints on mSUGRA model

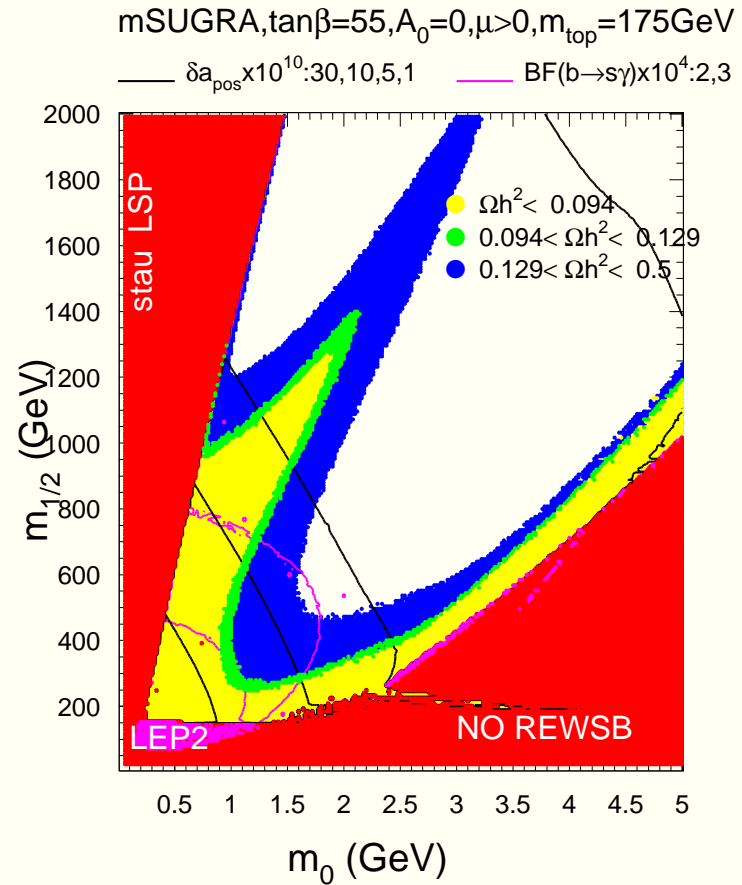
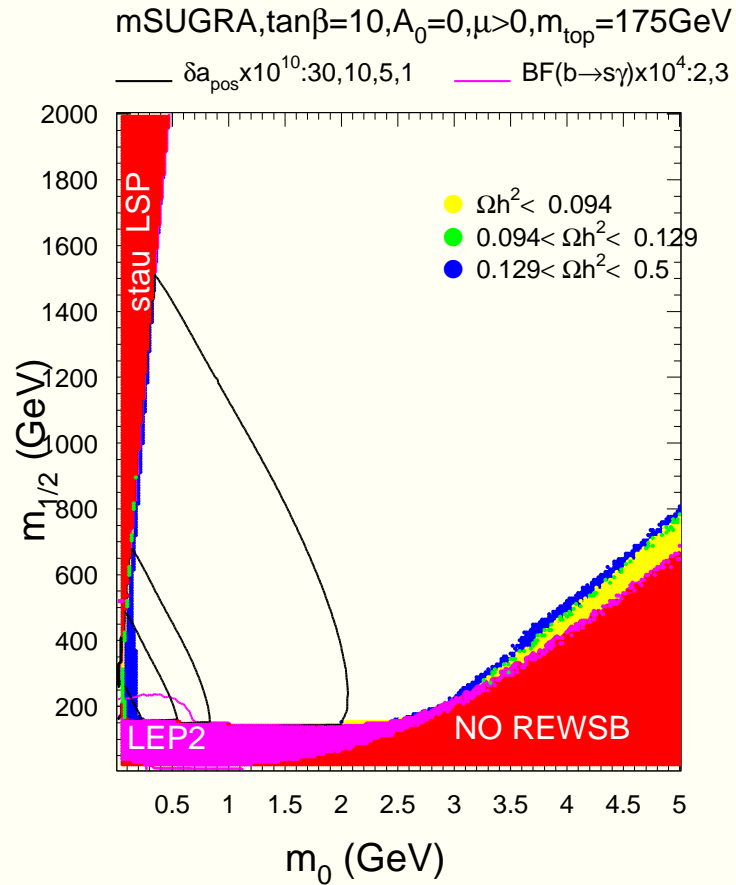

Main mSUGRA regions consistent with WMAP

- ★ bulk region (low m_0 , low $m_{1/2}$)
- ★ stau co-annihilation region ($m_{\tilde{\tau}_1} \simeq m_{\tilde{Z}_1}$)
- ★ HB/FP region (large m_0 where $|\mu| \rightarrow \text{small}$: Feng, Matchev, Moroi)
- ★ A -funnel ($2m_{\tilde{Z}_1} \simeq m_A, m_H$)
- ★ h corridor ($2m_{\tilde{Z}_1} \simeq m_h$)
- ★ stop co-annihilation region (particular A_0 values $m_{\tilde{t}_1} \simeq m_{\tilde{Z}_1}$)

Constraints as χ^2 on mSUGRA model

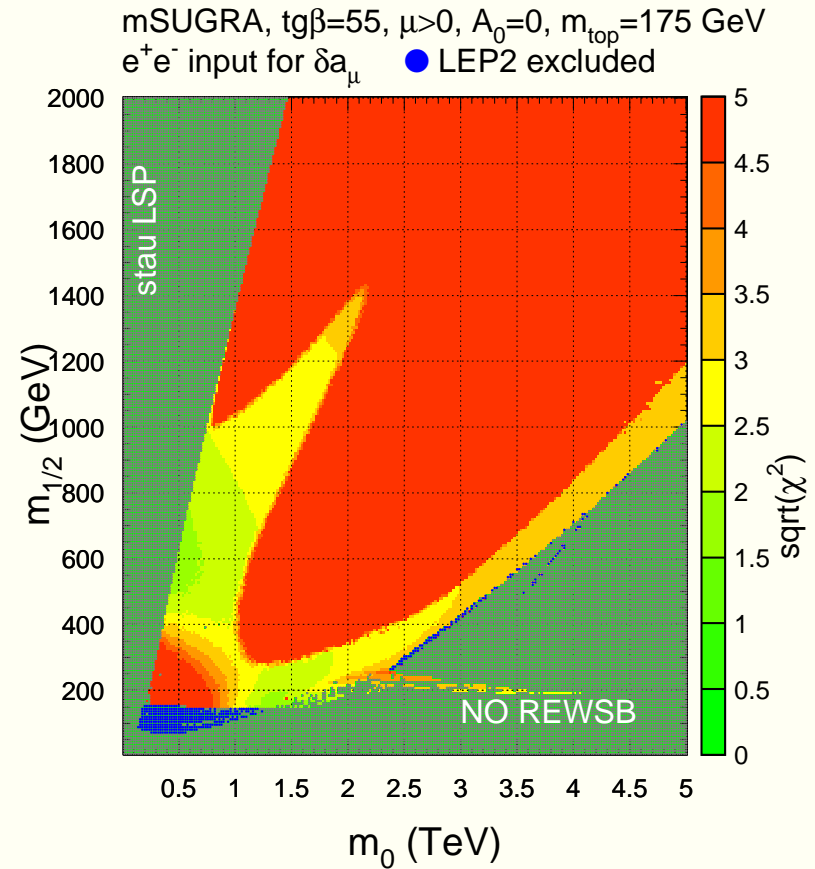
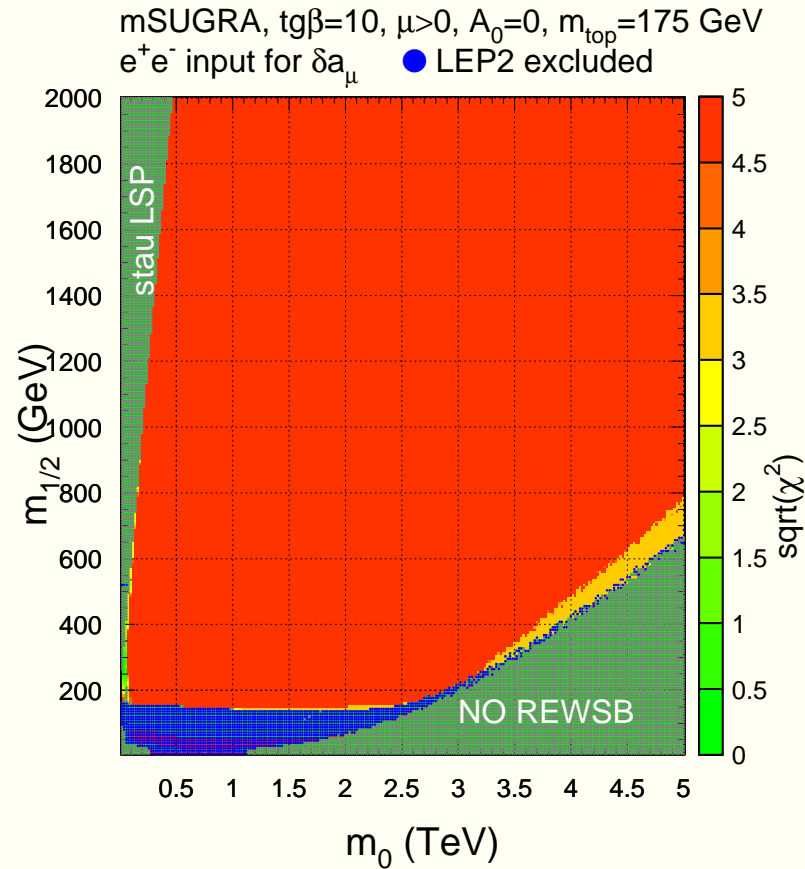

Direct detection of SUSY DM

★ Direct search via neutralino-nucleon scattering

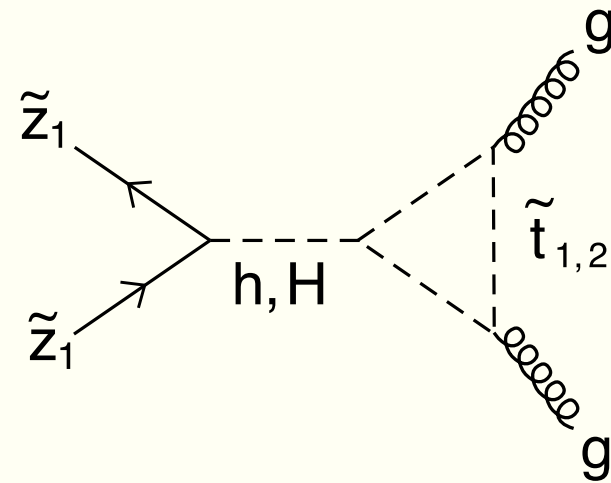
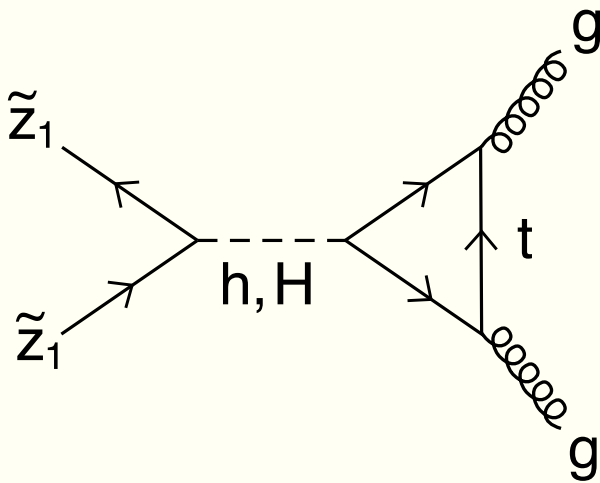
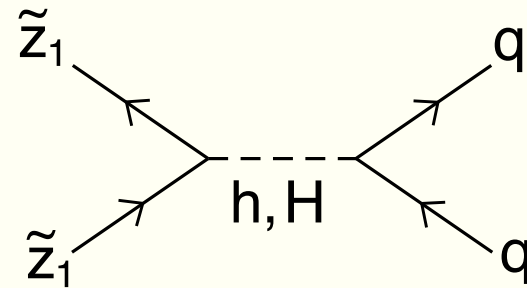
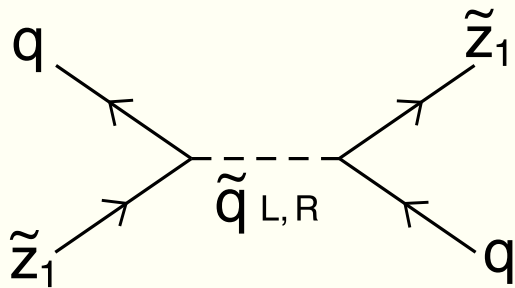

Direct detection of SUSY DM

scan over mSUGRA space :

- ★ Stage 1:
 - CDMS1, Edelweiss, Zeplin1
- ★ Stage 2:
 - CDMS2, CRESST2, Zeplin2, Edelweiss2
- ★ Stage 3:
 - SuperCDMS, Zeplin4, Xenon, CLEAN

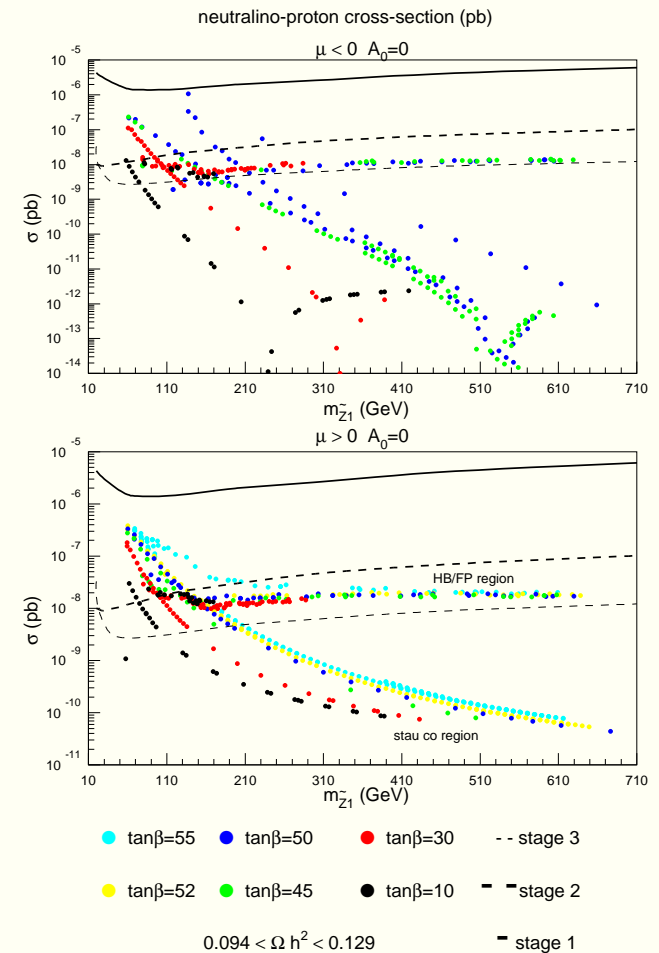

Indirect detection (ID) of SUSY DM: ν -telescopes

- ★ $\tilde{Z}_1 \tilde{Z}_1 \rightarrow b\bar{b}$, etc. in core of sun (or earth): $\Rightarrow \nu_\mu \rightarrow \mu$ in ν telescopes
 - Amanda, Icecube, Antares

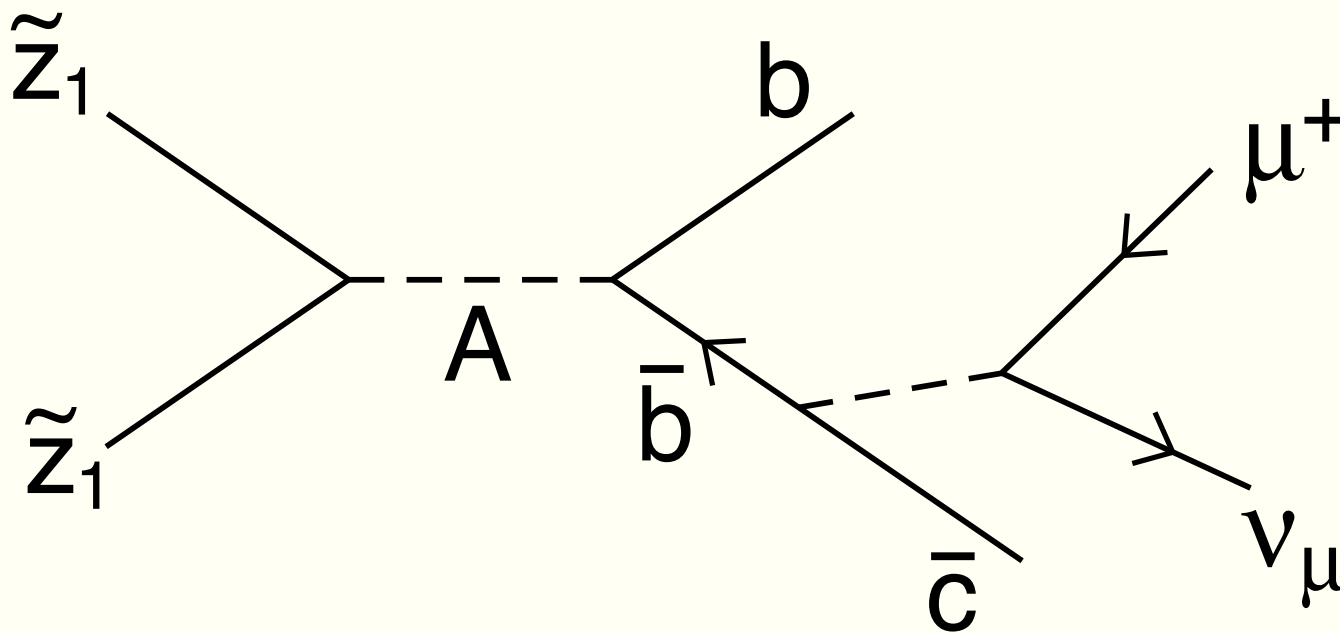

ID of SUSY DM: γ and anti-matter searches

- $\tilde{Z}_1 \tilde{Z}_1 \rightarrow q\bar{q}, \text{ etc.} \rightarrow \gamma$ in galactic core or halo
- $\tilde{Z}_1 \tilde{Z}_1 \rightarrow q\bar{q}, \text{ etc.} \rightarrow e^+$ in galactic halo
- $\tilde{Z}_1 \tilde{Z}_1 \rightarrow q\bar{q}, \text{ etc.} \rightarrow \bar{p}$ in galactic halo
- $\tilde{Z}_1 \tilde{Z}_1 \rightarrow q\bar{q}, \text{ etc.} \rightarrow \bar{D}$ in galactic halo
 - \bar{D} recently detected (BESS)
 - future: Gaseous Antiparticle Spectrometer (GAPS)-
 - * slow \bar{D} ; look for x-rays after capture on atoms
 - * HB and Profumo, astro-ph/0510722

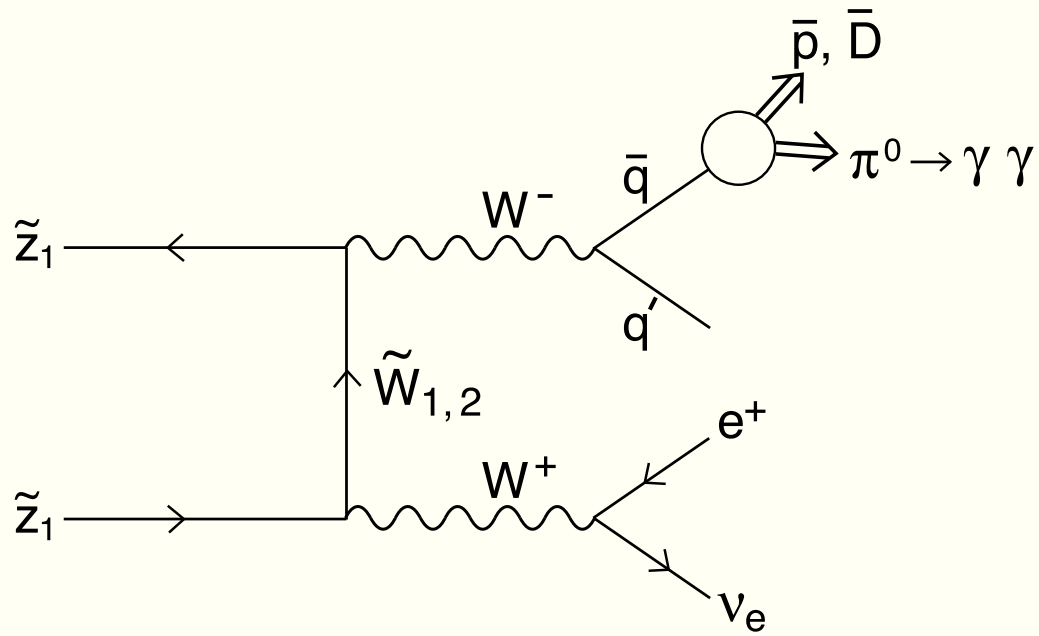

Rates for γ s, e^+ s, \bar{p} s vs. m_0 for fixed $m_{1/2} = 550$ GeV, $\tan\beta = 50$

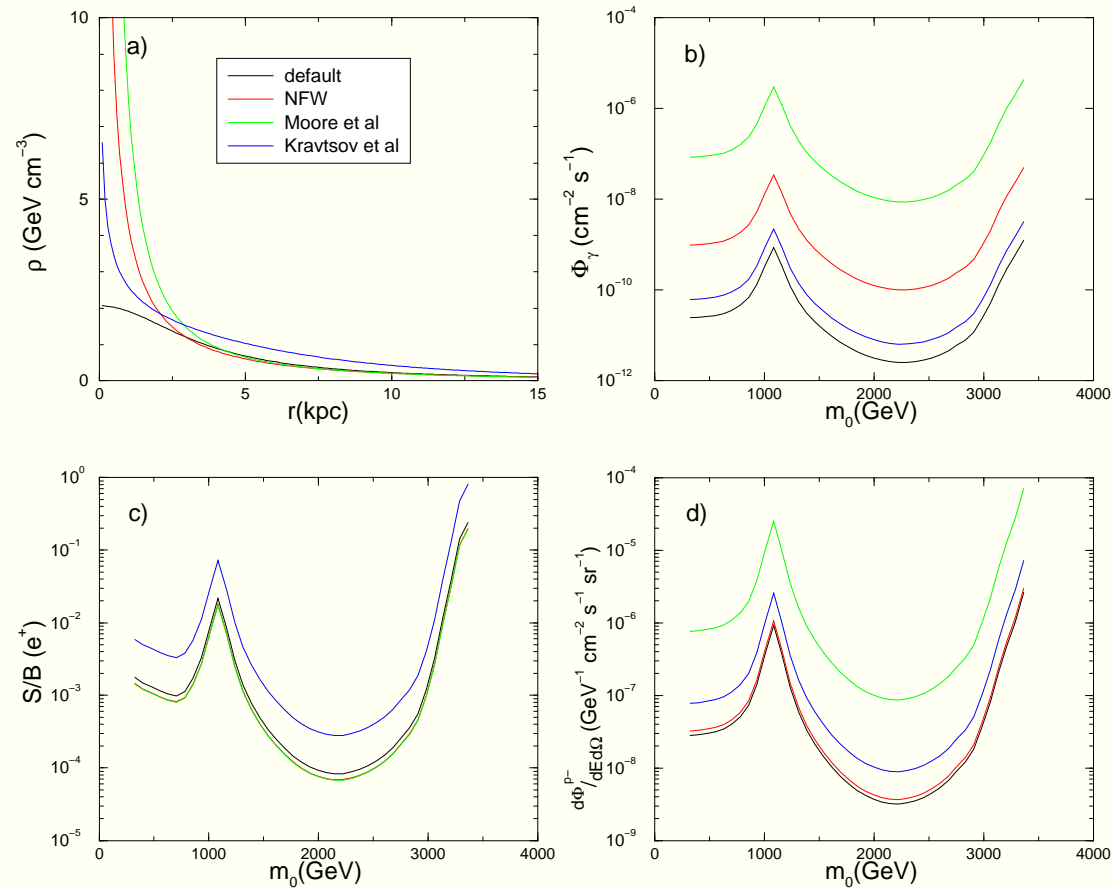

- HB, Belyaev, Krupovnickas and O' Farrill
- rates enhanced in A -funnel and HB/FP region (MHDM)

Sparticle reach of all colliders and relic density

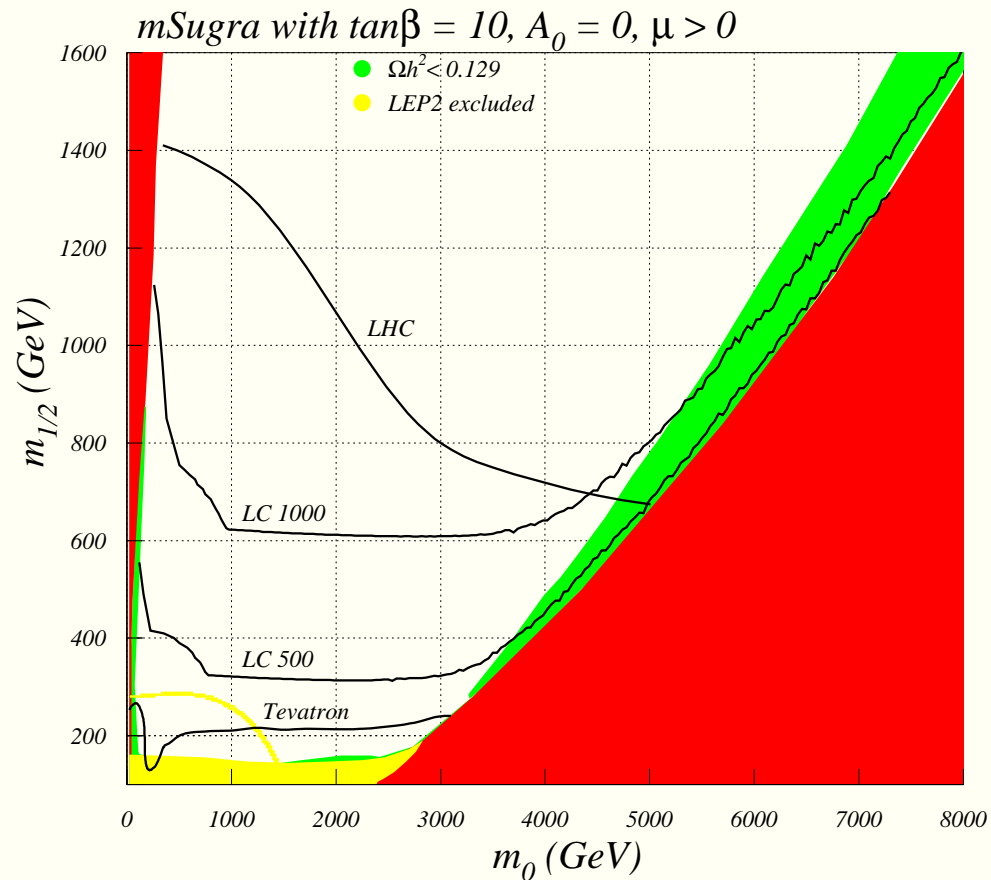

HB, Belyaev, Krupovnickas, Tata

Sparticle reach of all colliders and relic density

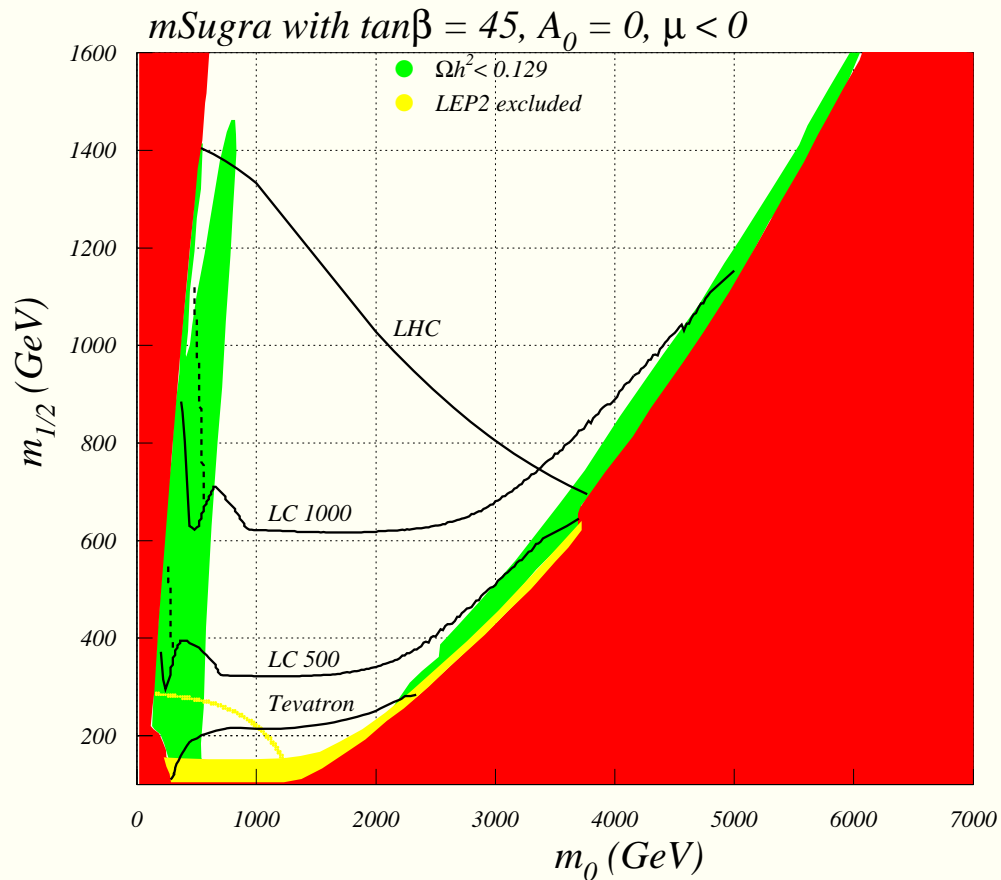

HB, Belyaev, Krupovnickas, Tata

Direct and indirect detection of neutralino DM

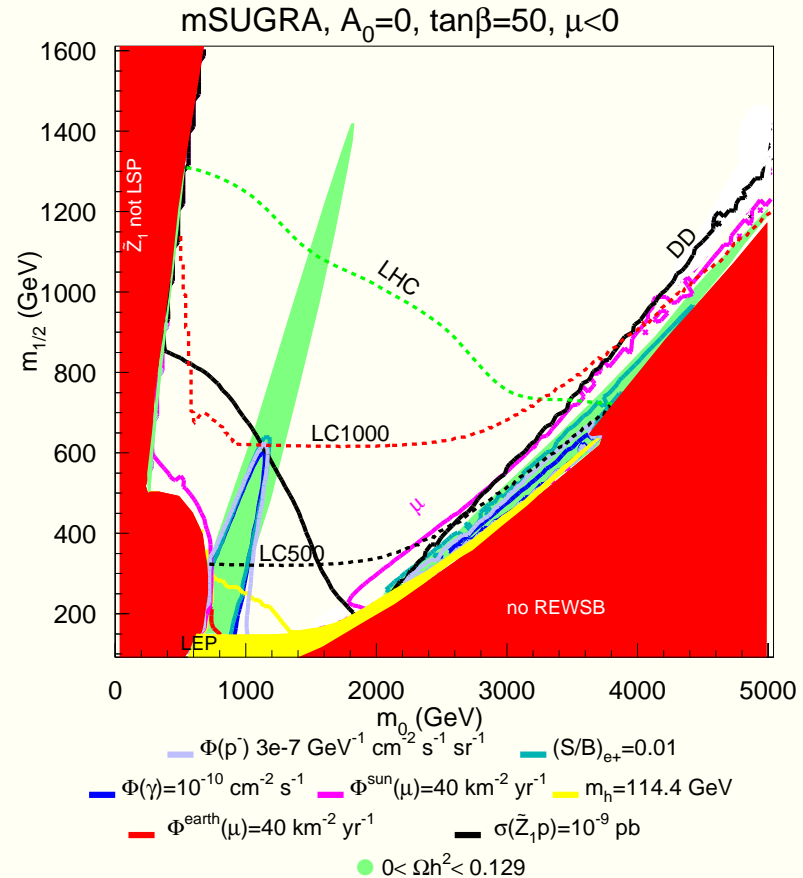
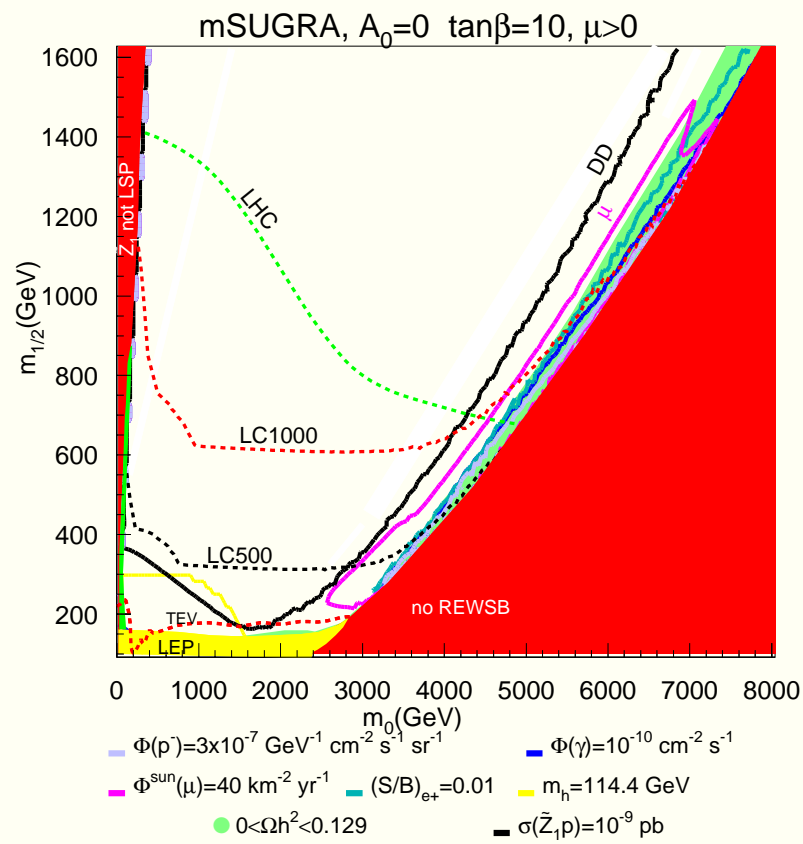

HB, Belyaev, Krupovnickas, O'Farrill

SuperWIMPs (e.g. \tilde{G} in SUGRA or G in UED)

- ★ $m_{\tilde{G}} = F/\sqrt{3}M_* \sim \text{TeV}$ in Supergravity models
 - usually \tilde{G} decouples (but see Moroi et al. for BBN constraints)
 - if \tilde{G} is LSP, then calculate NLSP abundance as a thermal relic: $\Omega_{NLSP}h^2$
 - $\tilde{Z}_1 \rightarrow h\tilde{G}, Z\tilde{G}, \gamma\tilde{G}$ or $\tilde{\tau}_1 \rightarrow \tau\tilde{G}$ possible
 - * lifetime $\tau_{NLSP} \sim 10^4 - 10^8$ sec
 - * constraints from BBN, CMB not too severe
 - * DM relic density is then $\Omega_{\tilde{G}} = \frac{m_{\tilde{G}}}{m_{NLSP}} \Omega_{NLSP}$
 - * Feng, Rajaraman, Su, Takayama; Ellis, Olive, Santoso, Spanos
 - \tilde{G} undetectable via direct/indirect DM searches
 - unique collider signatures:
 - * $\tilde{\tau}_1 = \text{NLSP}$: stable charged tracks
 - * can collect NLSPs in e.g. water (slepton trapping)
 - * monitor for $NLSP \rightarrow \tilde{G}$ decays

SUGRA models with non-universal scalars

- Normal scalar mass hierarchy NMH: HB, Belyaev, Krupovnickas, Mustafayev
- $m_0(1) \simeq m_0(2) \ll m_0(3)$ (preserve FCNC bounds)
- motivation: reconcile $BF(b \rightarrow s\gamma)$ with $(g - 2)_\mu$ anomaly

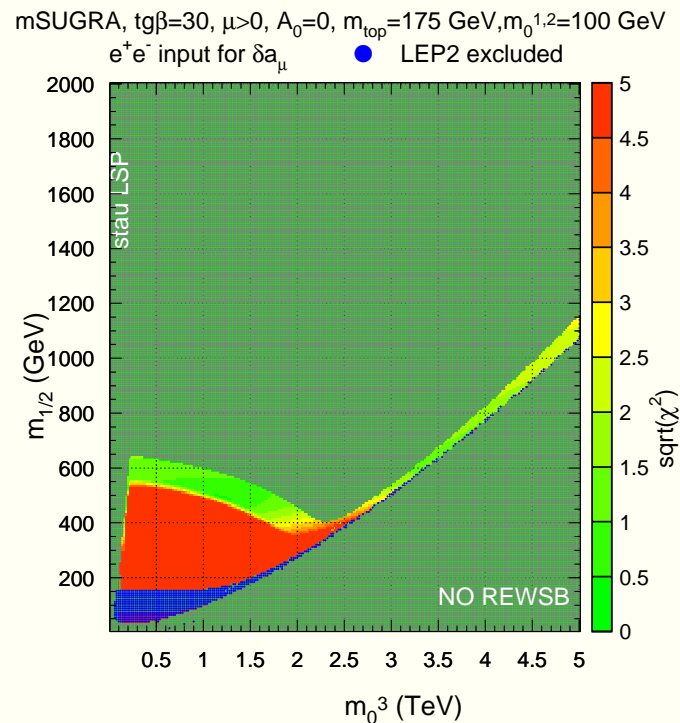

SUGRA models with non-universal Higgs mass (NUHM1)

- $m_{H_u}^2 = m_{H_d}^2 \equiv m_\phi^2 \neq m_0$: HB, Belyaev, Mustafayev, Profumo, Tata
- motivation: $SO(10)$ SUSYGUTs where $\hat{H}_{u,d} \in \phi(10)$ while matter $\in \psi(16)$
- $m_\phi^2 \gg m_0 \Rightarrow$ higgsino DM for any $m_0, m_{1/2}$
- $m_\phi^2 < 0 \Rightarrow$ can have A -funnel for any $\tan\beta$

$m_0=300\text{GeV}, m_{1/2}=300\text{GeV}, \tan\beta=10, A_0=0, \mu>0, m_t=178\text{GeV}$

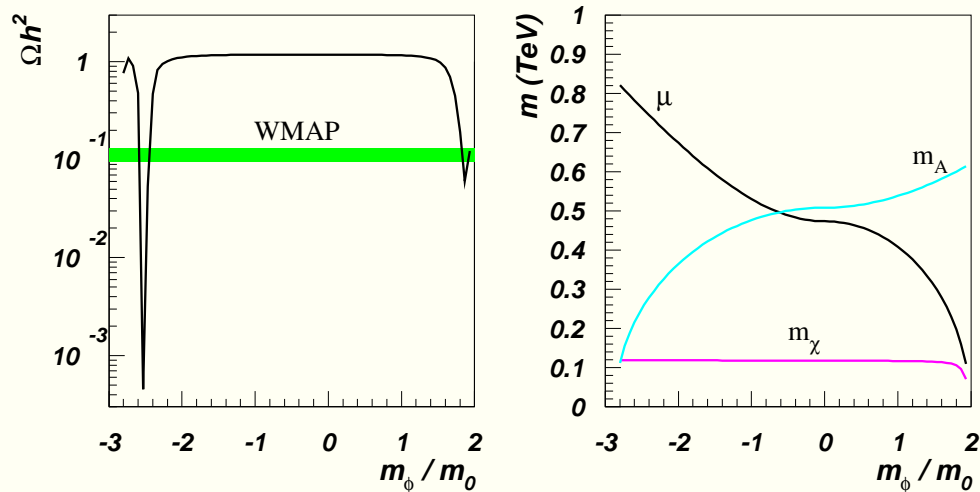

NUHM2 (2-parameter case)

- $m_{H_u}^2 \neq m_{H_d}^2 \neq m_0$: HB, Belyaev, Mustafayev, Profumo, Tata
- motivation: $SU(5)$ SUSYGUTs where $\hat{H}_u \in \phi(5)$, $\hat{H}_d \in \phi(\bar{5})$
- can re-parametrize $m_{H_u}^2$, $m_{H_d}^2 \leftrightarrow \mu$, m_A (Ellis, Olive, Santoso)
- large S term in RGEs \Rightarrow light \tilde{u}_R , \tilde{c}_R squarks, $m_{\tilde{e}_L} < m_{\tilde{e}_R}$

NUHM2: $m_0=300\text{GeV}$, $m_{1/2}=300\text{GeV}$, $\tan\beta=10$, $A_0=0$, $m_t=178\text{GeV}$

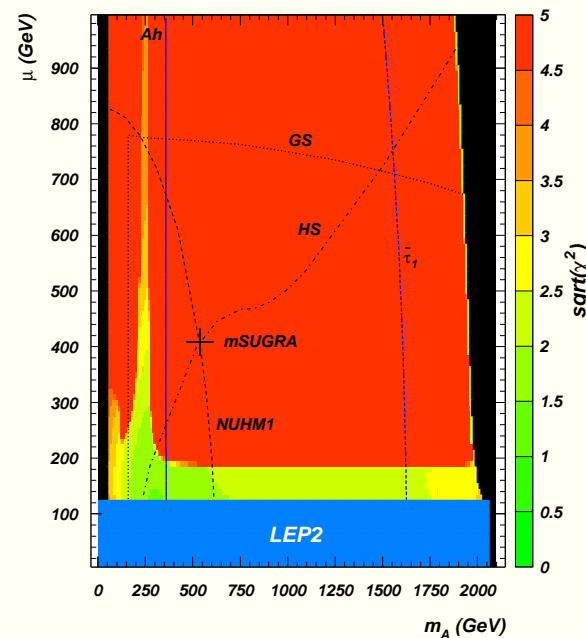

Gaugin mass non-universality

- $M_1 \neq M_2 \neq M_3$: HB, TK, AM, EP, SP, XT
- motivation: SUSYGUTs where gauge kinetic function transforms non-trivially
- $M_2 \sim M_1$ at M_{GUT} : mixed wino dark matter (MWDM)
- $M_2 \simeq -M_1$ at M_{GUT} : bino-wino co-annihilation (BWCA)

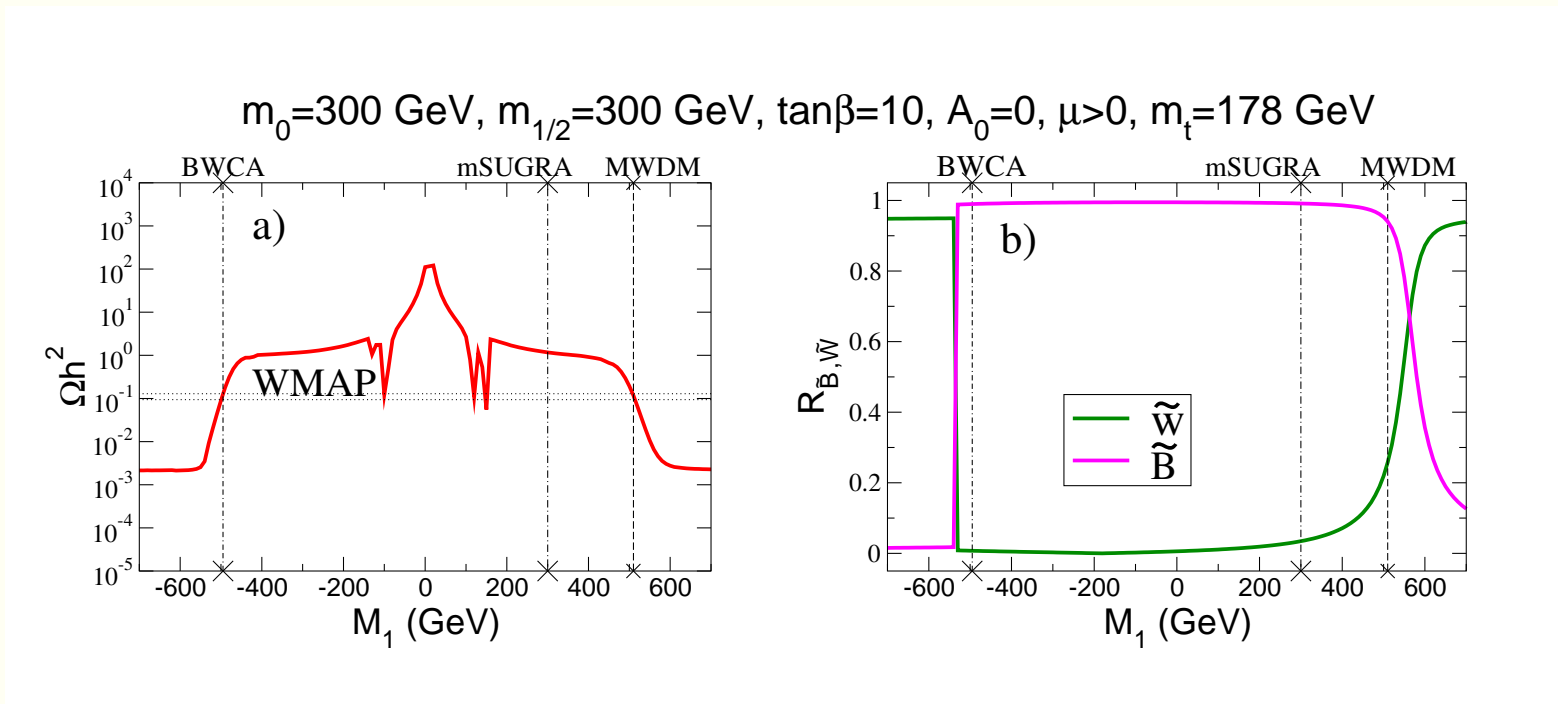

Gaugino mass non-universality: low M_3 case

- $M_3 < M_1 \sim M_2$: HB, TK, AM, EP, SP, XT
- motivation: mixed-moduli AMSB models
- lower $M_3 \rightarrow$ low $m_{\tilde{q}} \rightarrow$ low $\mu \rightarrow$ mixedhiggsinoDM

$m_0=300$ GeV, $m_{1/2}=300$ GeV, $\tan\beta=10$, $A_0=0$, $\mu>0$, $m_t=175$ GeV

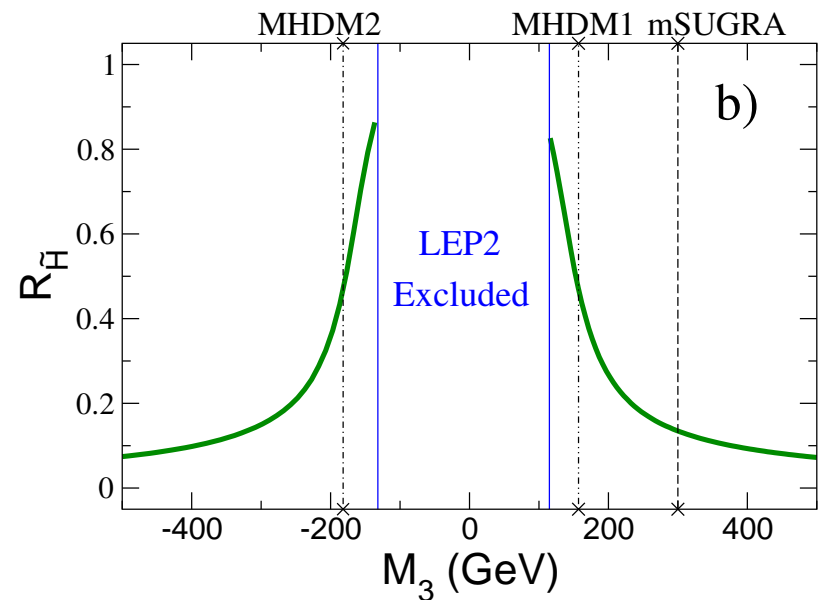
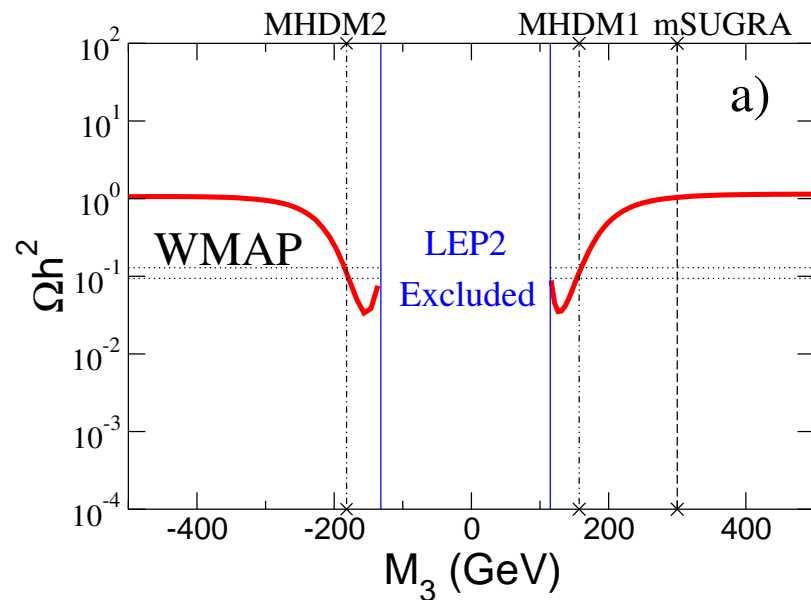

SUGRA models beyond MSSM: NMSSM

★ Add extra singlet SF \hat{S}

- motivation: introduce μ parameter via SUSY breaking
- 3 neutral scalar higgs, 2 pseudoscalars and 5 neutralinos

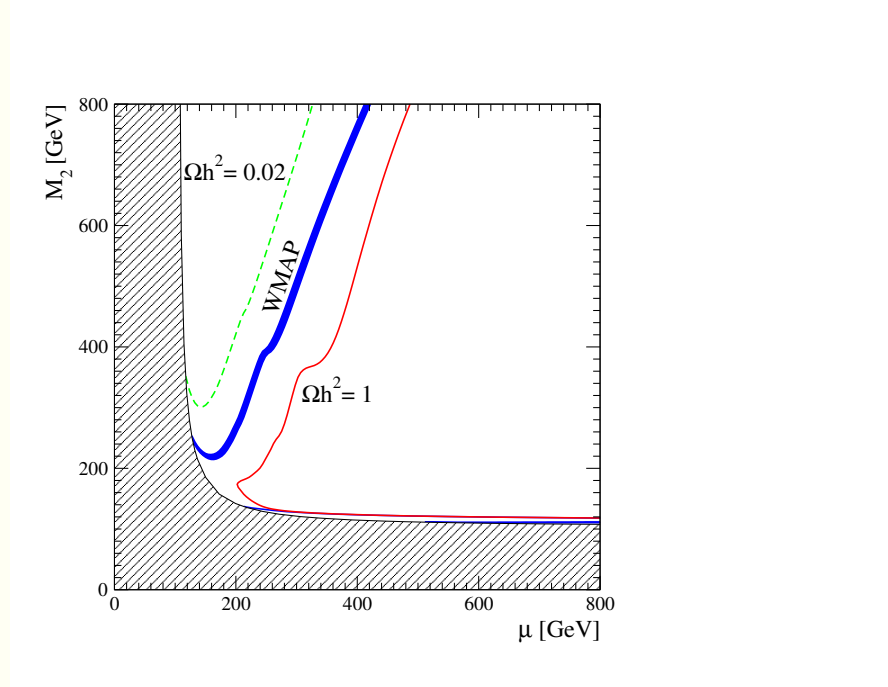

Belanger, Boudjema, Hugonie, Pukhov, Semenov

Conclusions

- ★ Overwhelming evidence for CDM in the universe
- ★ Numerous candidate CDM particles
 - Axions: searches ongoing (ADMX group)
- ★ SUSY LSP: thermal relic from Big Bang
- ★ Various regions \Rightarrow distinct collider/DM signatures
- ★ Direct/ indirect DM detection prospects
- ★ Detection at colliders: Tevatron, LHC, ILC
- ★ SuperWIMPs: \tilde{G} in SUSY; G in UED
- ★ Beyond mSUGRA:
 - normal mass hierarchy, NUHM1, NUHM2 models
 - gaugino mass non-universality: MWDM, BWCA, low M_3
 - NMSSM